

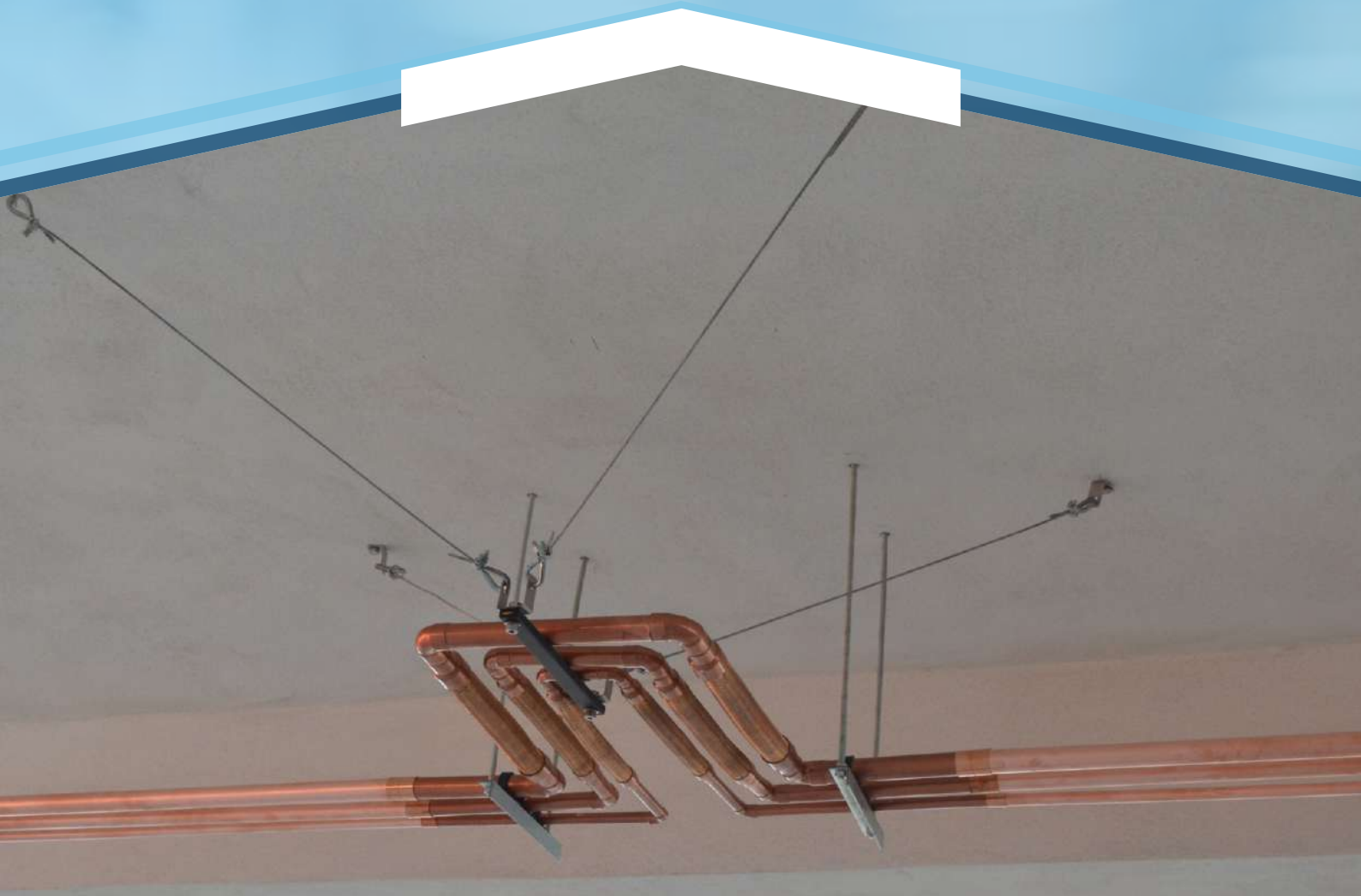

SCHÖNN
Medizintechnik GmbH

SEISMIC EXPANSION JOINT FOR MEDICAL GAS PIPING



SEISMIC EXPANSION JOINT

SEISMIC U-FLEX HOSES

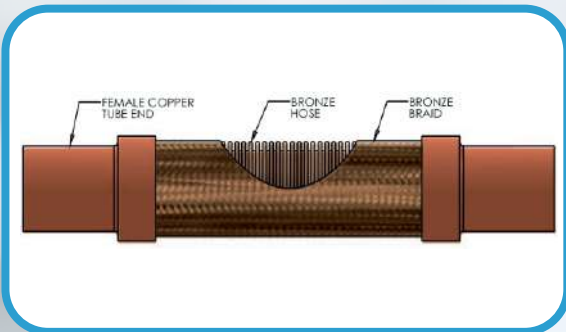
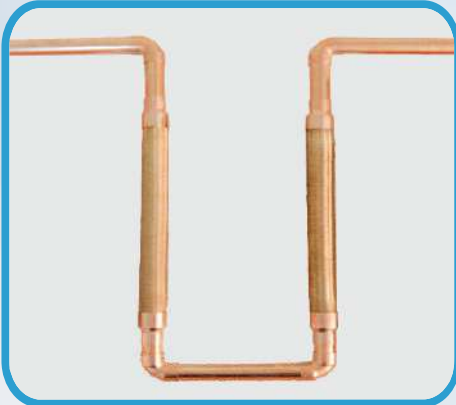

Seismic U-Flex hoses are the flexible bronze braided hoses and can be used widely in systems gas with their resistance to pressure and flexible structure. They are utilized for conducting gas, compensating the problems originated from installation, absorbing vibrations and expansions. With their variety of fitting options produced for almost every type of connections, they can be used as a ready-to-install assembly part in every connection point.

The U-Flex Hose's design is the only flexible pipe loop that absorbs and compensates pipe movement in six degrees of freedom. (three coordinates axes, plus rotation about those axes simultaneously.) The multiplane movement design can reduce expansion devices required in a piping system by up to 50%. It is the safest and most reliable means of absorbing movement resulting from thermal changes and random seismic shifts in a piping system.

Simplifies Piping Design

The U-Flex Hoses do not impose pressure thrust on the piping system. The braid is designed to take the stress of pressurization containing the core, reducing anchor loads by 93% compared to mechanical pipe loops and 98% less than expansion joints. U-Flex Hoses also eliminate pipe guides required by traditional pipe designs such as mechanical pipe loops or expansion joints.

Compact Design increases useable space and reduces system cost

The U-Flex Hoses use 64% less space than a mechanical pipe loop, and eliminates six welds. Fewer fittings and welds can be achieved in the piping system by positioning the U-Flex Hoses at directional changes and rotating one of the U-Flex elbows during manufacturing to incorporate directional change, eliminating 90° elbows in the field. It can also be designed to incorporate elevation changes in the piping system, saving space, fewer fittings and welds.

Standards

Our Seismic Flexible Hoses compatible with ASCE 7-02 Minimum Design Loads for Buildings and Other Structures Section 9-6 Earthquake Loads, Table 9.6.1.7 Seismic Design Category C.D.E.F.

"U" Design

Variety of sizes & end fitting combinations

Nested configurations

Maximum vibration absorption

Benefits:

Compensates for offset, lateral and axial motion

Saves space

Meets most installation requirements

Simplifies protection of multi-pipe runs

Seismic protection of equipment & piping

SEISMIC EXPANSION JOINT

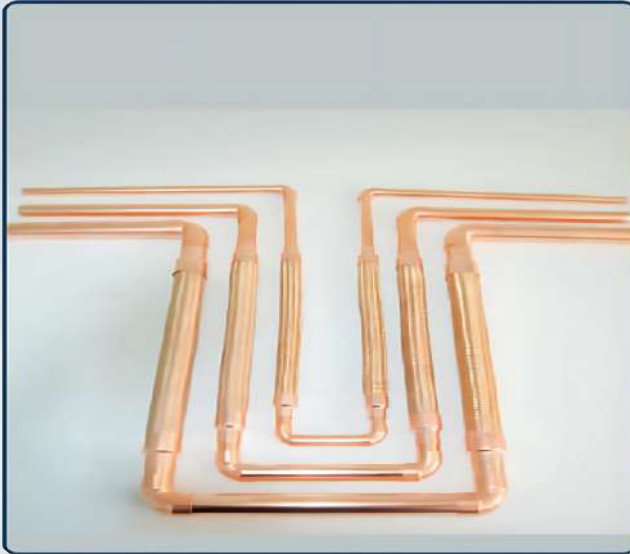

The U-Flex Hoses are generally used in four types of applications:

- To correct problems of misalignment
- To provide flexibility in manual handling operations
- To compensate for intermittent or constant movement
- To absorb vibration

In all of these types, careful hose selection, design of the assembly, and installation are important for optimal service life. The flexibility of a hose is determined by its mechanical design and the inherent flexibility of its material.

FEATURES

The U-Flex Hoses are extremely critical accessories and used for protecting vital installations such as medical gas systems from seismic motion like earthquakes.

This Seismic Connection Hoses provide flexibility to piping systems and used to absorb possible seismic movements in three axis.

In addition to seismic protection, installation cost is lower comparing to conventional expansion joints considering lesser need for space and fixing points and ability for nested installations.

Comparing to use expansion joints and conventional piping to absorb vibrations, imposing lesser load to main pipeline is one of their significant advantages.

Braided flexible hoses are consist of two parallel sections of braided bronze hose, a 180 degree return bend, with inlet and outlet 90 degree elbow connections.

The hoses are engineered to move in all three planes, and is impart no thrust loads to system anchors.

Materials of construction of the Schön U-Flexes are bronze Hose with bronze braid and copper ends.

End fittings are made of copper and welded with %5 Brass.

Seismic U-Flex hoses are designed to meet the design pressure, temperature, and movement requirements for the system.

Hoses is capable of accommodating piping system and equipment movements and vibration as needed.

Bronze flexible hoses, braided and their assemblies are designed to allow frequent movement or flexibility.

Flexible hoses are the standard of the industry in braided connectors for copper piping. This style connector is constructed with bronze flexible hose & braid for high- pressure ratings.

Flexible hose is offered with standard copper sweat/tube ends.

Its nominal size is 15,22,28,35,42,54. Other nominal sizes can be produced in accordance with the customer's requirements.

SEISMIC EXPANSION JOINT

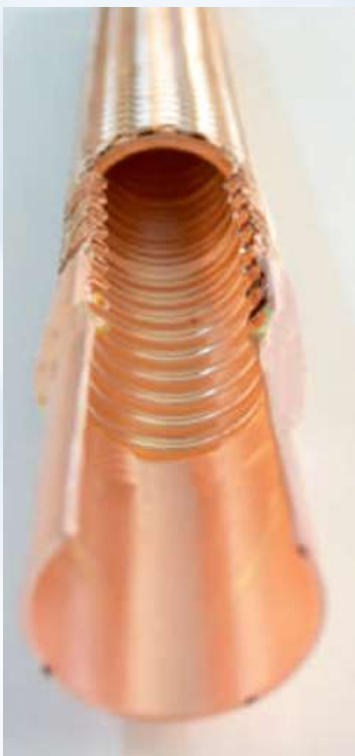
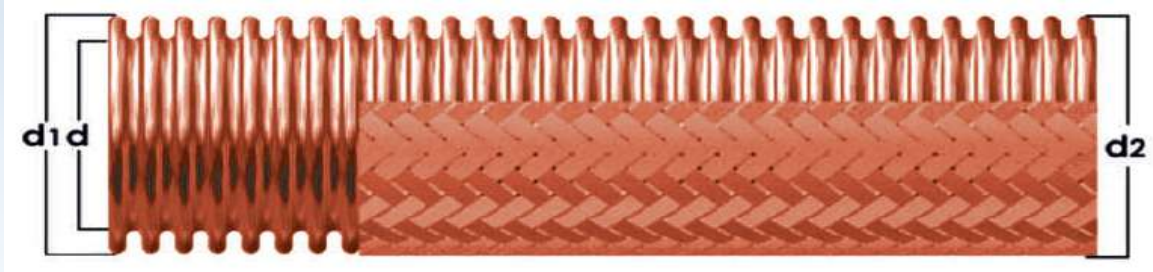

Product code	Dimensions						
	PIPE SIZE DN		Inner Diameter	Outer Diameter		d d1 d2	Max. Working Pressure
	∅ copper pipe	∅ U-flex pipe	d	d1	d2	tol. (±)	
SEISMIC U-FLEX-15mm	15mm	15mm	13.4	20.2	22.1	0.20	30 bar
SEISMIC U-FLEX-22mm	22mm	22mm	19.2	26.0	27.0	0.20	30 bar
SEISMIC U-FLEX-28mm	28mm	28mm	23.3	31.2	33.1	0.30	25 bar
SEISMIC U-FLEX-35mm	35mm	35mm	31.3	39.6	43.0	0.30	25 bar
SEISMIC U-FLEX-42mm	42mm	42mm	37.4	48.4	54.0	0.30	20 bar
SEISMIC U-FLEX-54mm	54mm	54mm	49.8	59.8	65.2	0.40	20 bar
SEISMIC U-FLEX-76mm	76mm	54mm	49.8	59.8	65.2	0.40	10 bar
SEISMIC U-FLEX-108mm	108mm	54mm	49.8	59.8	65.2	0.40	10 bar

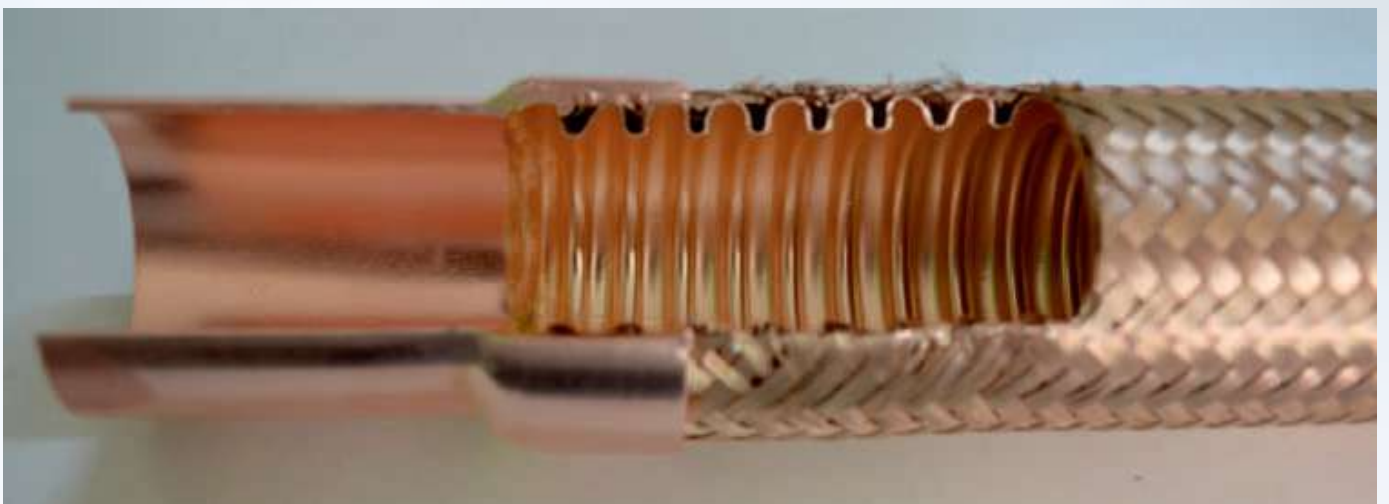

SEISMIC EXPANSION JOINT



THE SEISMIC ABILITIES TO MOVE

SEISMIC EXPANSION JOINT

Movement Capabilities

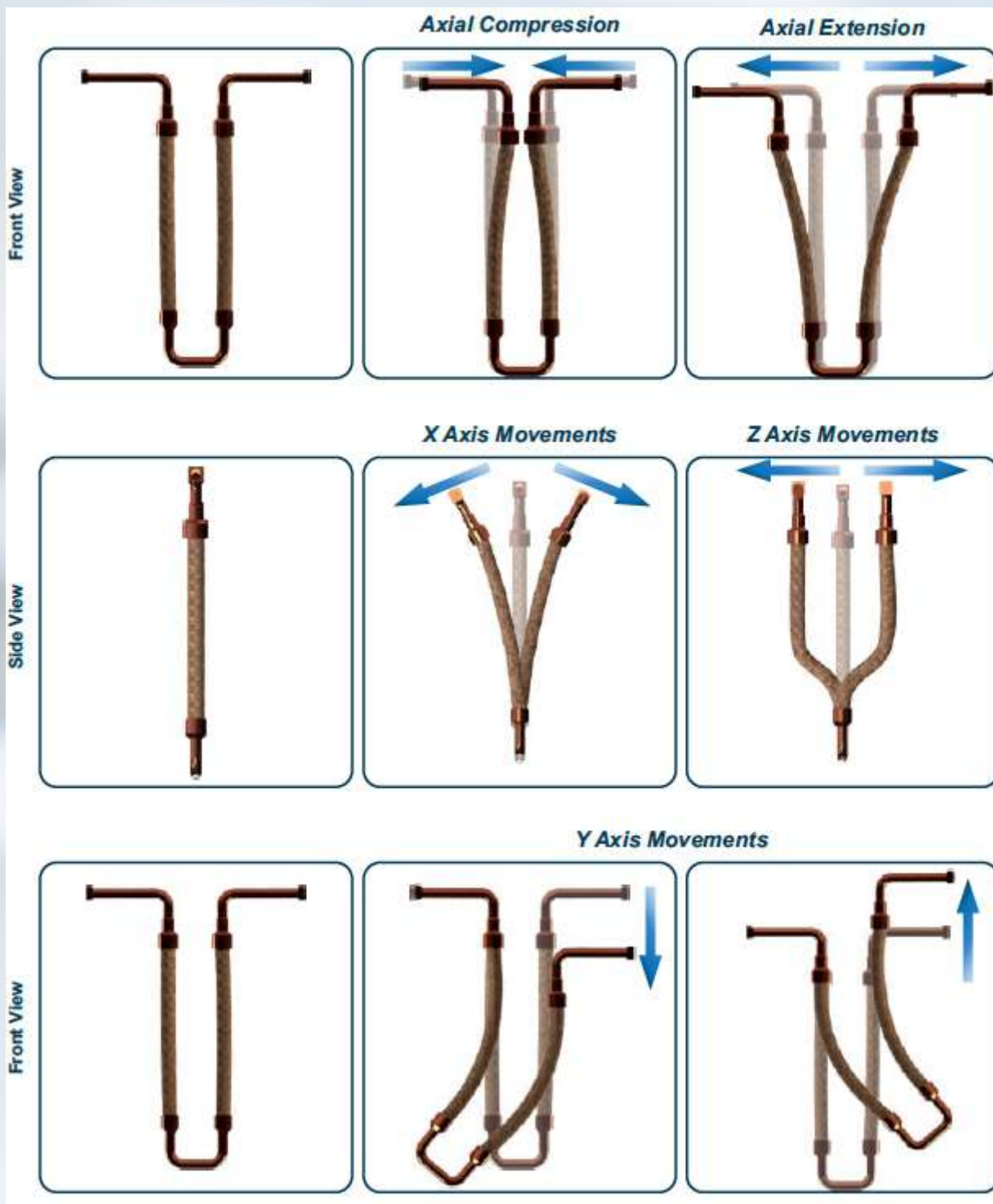

SEISMIC EXPANSION JOINT

THE SEISMIC ABILITIES TO MOVE



Seismic Connection Position

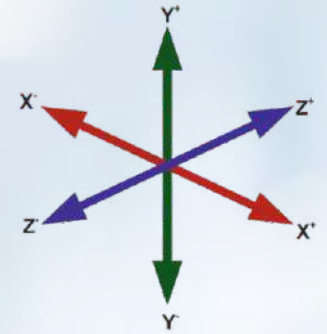

Seismic Horizontal Displacement

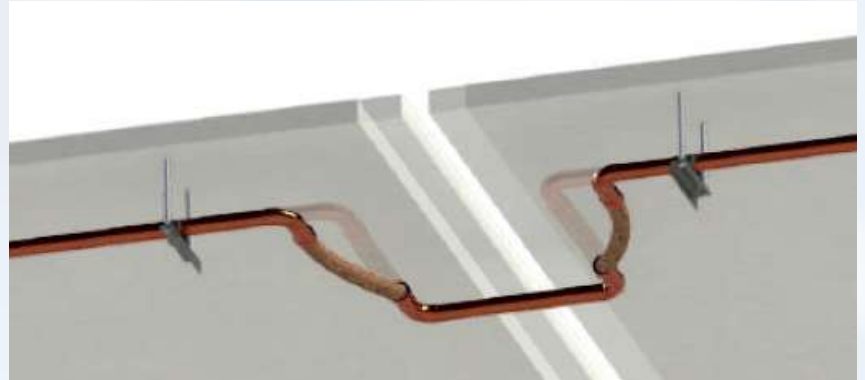

Seismic Vertical Displacement



Seismic Z Axis Displacement



SEISMIC EXPANSION JOINT

Anchor Loads
5,176 lbs

Anchor Loads
5,176 lbs

Anchor Loads
1,200 lbs

Anchor Loads
1,200 lbs

Anchor Loads
83 lbs

Anchor Loads
83 lbs

Design Conditions:

- Pipe: copper pipe
- Movement: x,y,z axial
- 12-15-22-28-35mm pipes :30cm
- 42,54mm pipes: 20cm
- 76-108mm pipes: 10cm
- Operation working Pressure: max. 30 bar
- Temperature: -45°C to 230°C

- 98% less anchor load than Bellows Expansion Joint
- 74% less anchor load than Hard Pipe Loop
- 69% less space required than Hard Pipe Loop

The U-Flex Hoses flexibility translates into compactness, requiring a fraction of the space of hard pipe loops. Run can be made smaller, tighter and with fewer guides and supports than are required for hard pipe loops.

A single Flexible Hose can be designed for a large movements, eliminating multiple expansion joint locations. Compared to bellows type joints, the U-Flex Hoses has incredible flexibility and zero pressure thrust.

This means a low force to compress, insignificant anchor loads, and minimal guiding requirements. The flexible hoses combine two time proven technologies, the hard pipe loop and flexible bronze hose and braid.

Together they significantly reduce the size, anchor loads, support requirements and costs compared to a hard pipe loop designed for the same movement.

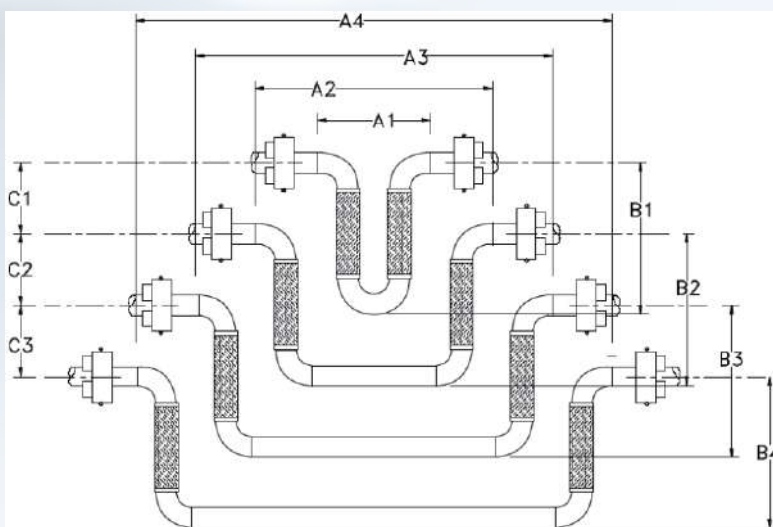

Nested Flexible Hoses can be used in parallel pipe runs to keep all the expansion device at one location.

They can be nested in any sequence, large inside of large and any number of pipes can be made in a nest.

The spool piece between the legs should not weigh more than the spring force required to bend the loops the full rated movement.

SEISMIC EXPANSION JOINT

INSTALLATION TYPE

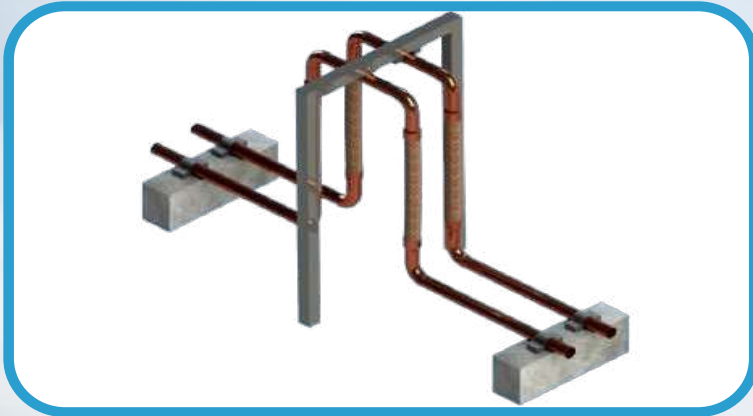

The flexible Loop extending upward

In this installation, a spring hanger is recommended to support the loop because the 180 return bend will travel up and down as the pipe expands and contracts.

Elevated Pipe Runs

Reduced spring rates, anchor loads and overall size, minimize the structural requirements of the pipe supports. Multiple hard pipe loops can be replaced by a single Flexible Loop.

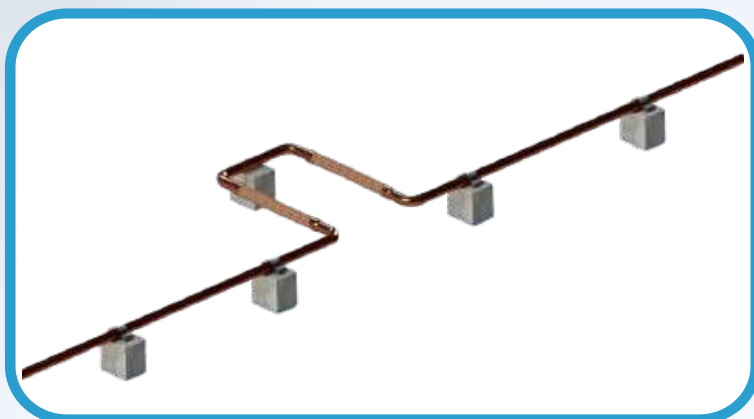
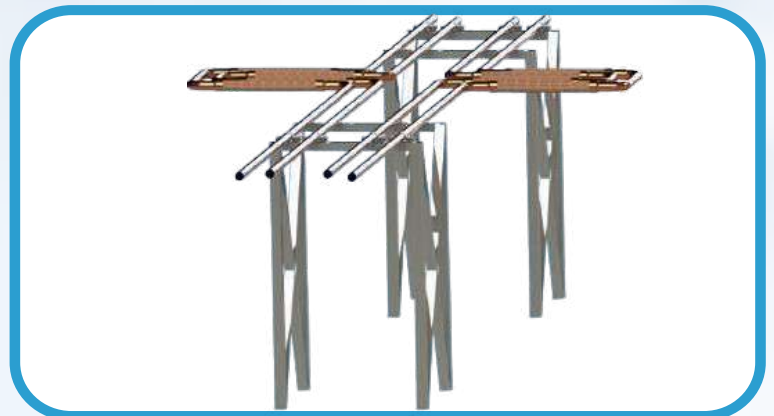

Horizontal Single Pipe Run

SEISMIC EXPANSION JOINT

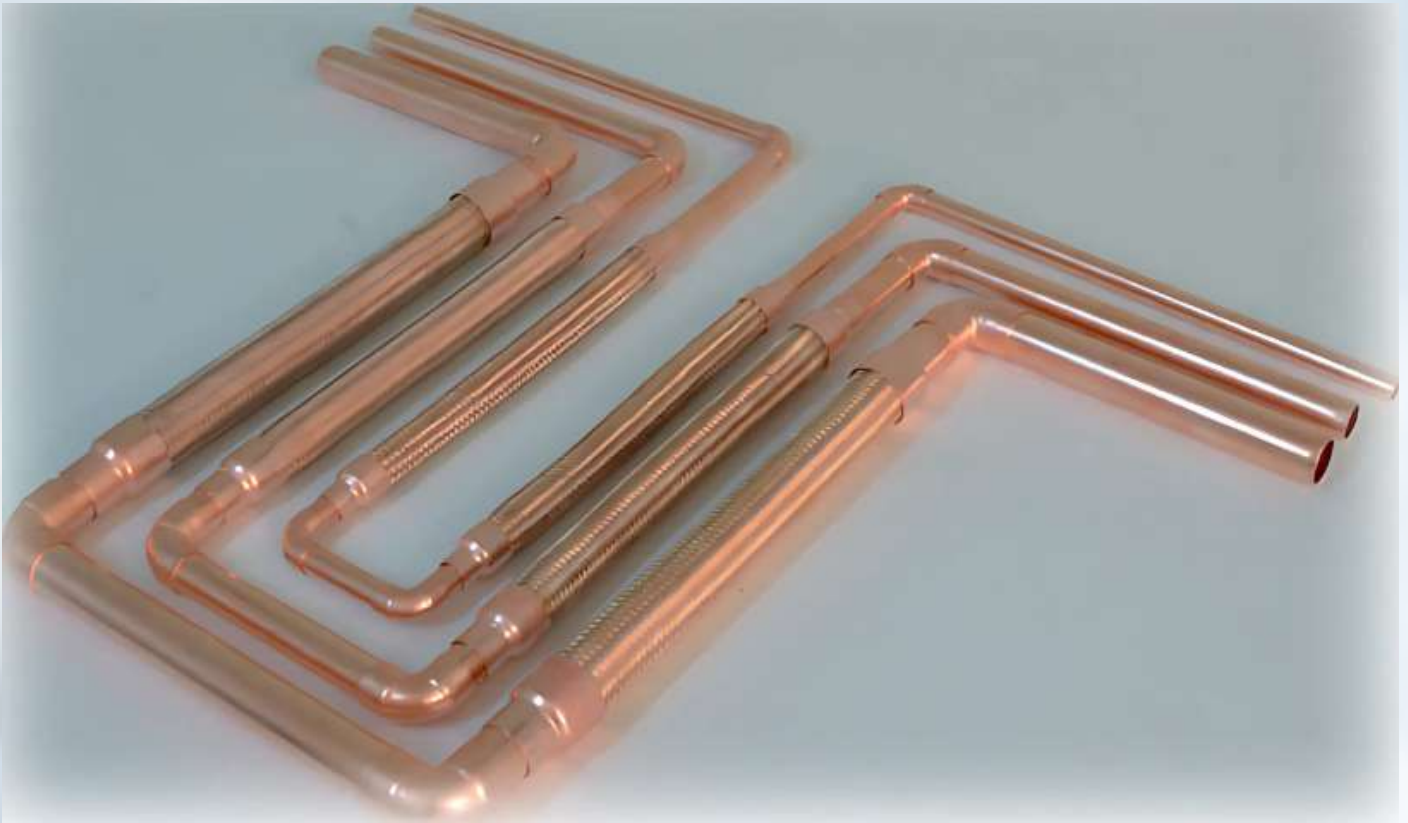

Typical Specification

Provide The U-Flex Hoses of size and material noted on drawing. Flexible Hose shall be designed to impart no thrust loads on the anchors. The Loop shall consist of two flexible section of hose and braid, two 90 degree elbows, and 180 degree return. Loops shall be installed in a neutral, precompressed, or pre-extended condition as required for the application. Loops installed hanging down shall have a drain plug. Loops installed straight up may be fitted with an automatic air release valve to purge air from the high point of the loop. Loops installed in any position other than hanging down must have the 180 degree return supported. Install Loop within four pipe diameters, both upstream and downstream, from a pipe guide or anchor.

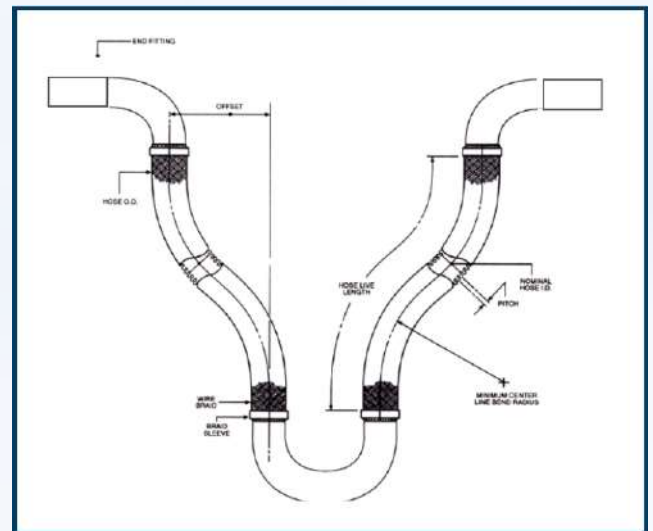
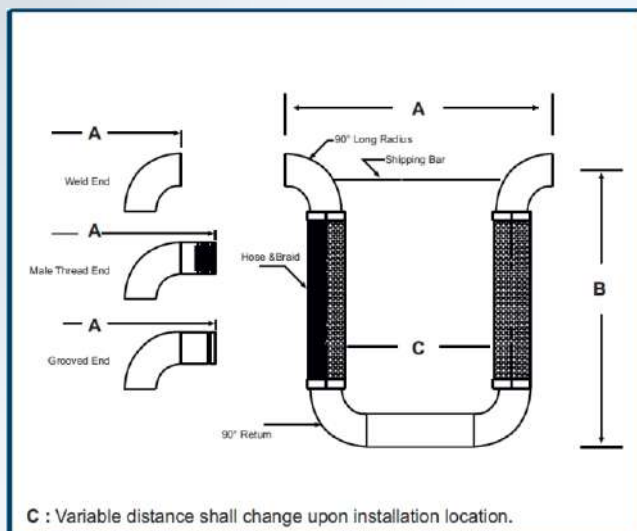

SEISMIC EXPANSION JOINT

Classification Of Motions

RANDOM MOTION

Such motion is non-predictable and may occur from the manual handling of a hose assembly. Care must be taken to prevent over bending of the hose and to avoid external abrading of the wire braid.

ANGULAR MOTION

This type of motion occurs when one end of a hose assembly is deflected in a simple bend with the ends not remaining parallel.

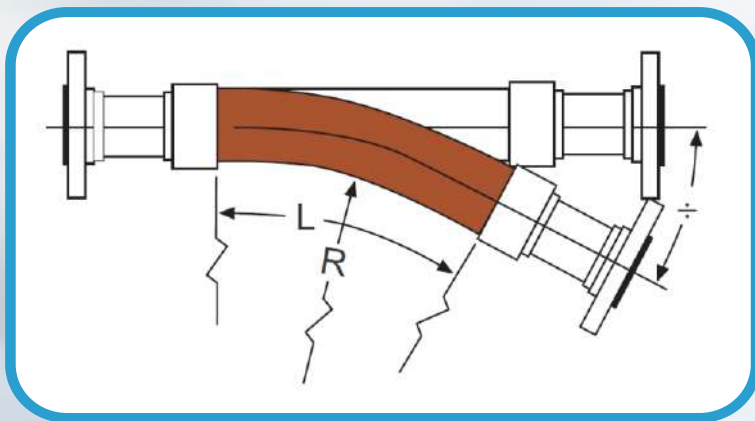

FORMULA: $L = \pi R \theta$

L = Live Hose Length (inches)
 $\pi = 3.1416$
R = Minimum Centerline Bend Radius for constant flexing (inches)
 θ = Angular Deflection (degrees)

OFFSET MOTION

Offset (lateral) motion occurs when one end of the hose assembly is deflected in a plane perpendicular to the longitudinal axis with the ends remaining parallel.

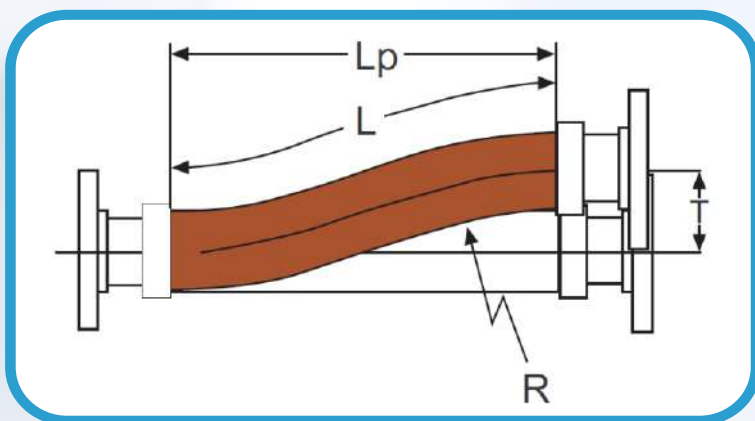

FORMULA: $L = \sqrt{6RT + T^2}$ $L_p = \sqrt{L^2 - T^2}$

L = Live Hose Length (inches)
Lp = Projected Live Hose Length (inches)
R = Minimum Centerline Bend Radius (inches)
T = Offset Motion to one side of Centerline (inches)

Note 1: When the offset motion occurs to both sides of the hose centerline, use total travel in the formula; i.e. 2 times "T".

Note 2: The offset distance "T" for constant flexing should never exceed 25% of the centerline bend radius "R".

Note 3: If the difference between "L" and "Lp" is significant, exercise care at installation to avoid stress on hose and braid at the maximum offset distance.

AXIAL MOTION

This type of motion occurs when there is extension or compression of the hose along its longitudinal axis. This motion is restricted to unbraided corrugated hose only and is limited to small movements, low pressures such as exhaust gas venting to atmosphere. (Bellows Type Expansion Joints and Expansion Loops are specifically designed for this type of movement.

SEISMIC EXPANSION JOINT

CLASSIFICATION OF MOTIONS

VERTICAL TRAVELING LOOP FORMULAE

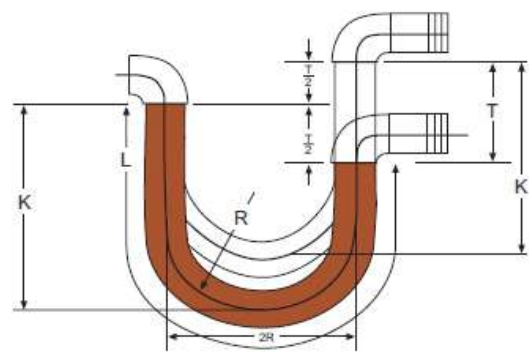

**FORMULA : $L = 4R + T/2$
 $K = 1.43R + T/2$**

T = Total Travel (inches)
 R = Minimum Centerline Bend Radius (inches)

HORIZONTAL TRAVELING LOOP FORMULAE

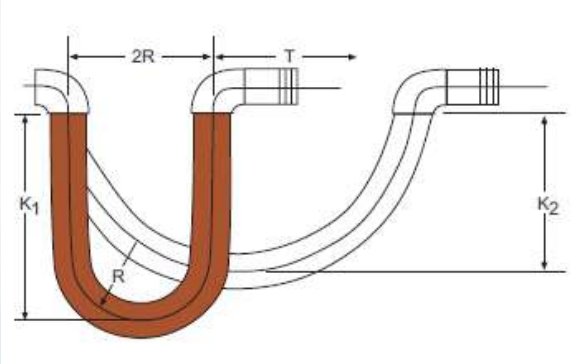

**FORMULA : $L = 4R + 1.57T$
 $K1 = 1.43R + 7.85T$
 $K2 = 1.43R + T/2$**

L = Live Hose Length (inches)
 K = Loop Length (inches)

VIBRATIONGRAPH

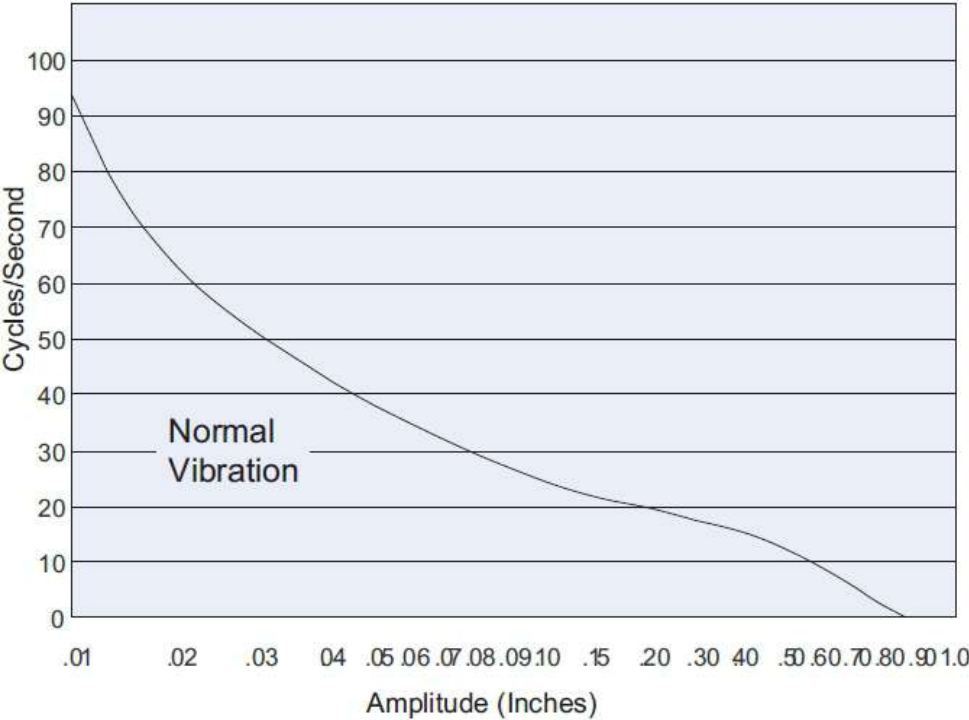

Expected vibration should fall below line on chart.

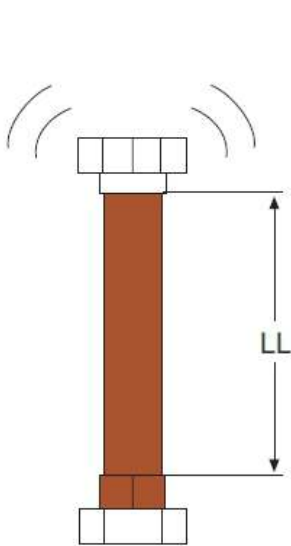

SEISMIC EXPANSION JOINT

INSTALLATION INSTRUCTIONS

1. DO NOT COMPRESS AXIALLY

In Metallic hose is limited to bending movements, and does not compress in the axial direction. (For this application, see our expansion joint and expansion loop catalogs.)

2. DO NOT TOROQUE

In A hose may be torqued by:

A) Twisting in Installations. A union or floating flange can be used at one end of the hose assembly to avoid twisting. Where flanges are used, the fixed flange end should be bolted into place before the floating flange end. Where a t threaded nipple and a union are used, the nipple end should be threaded into place, and then the union tightened into place using two wrenches.

B) Twisting on Flexures. Always install the hose so that flexing takes place in one plane only, and in the plane of bending. The hose should be installed such that the flexing occurs in the plane of bending only.

3. AVOID SHARP BENDS

In The minimum centerline bend radius for intermittent flexing should never be less than the values specified.

RIGHT

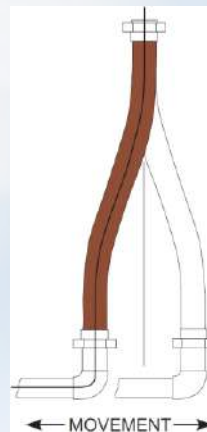

WRONG

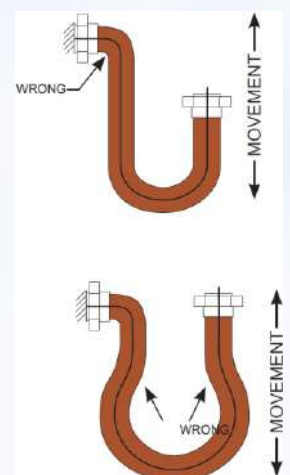
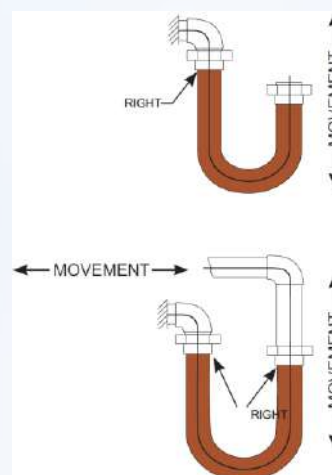
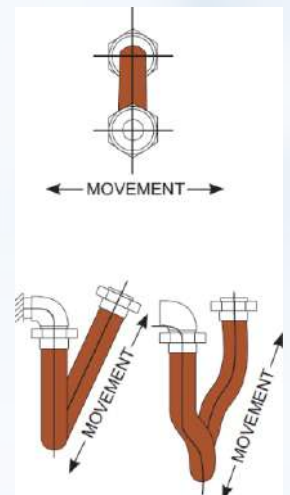
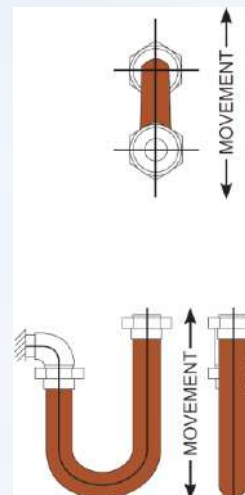
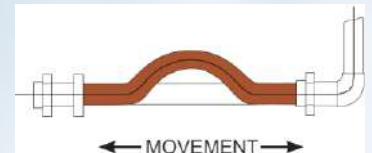

SEISMIC EXPANSION JOINT

THE HOSE FITTINGS

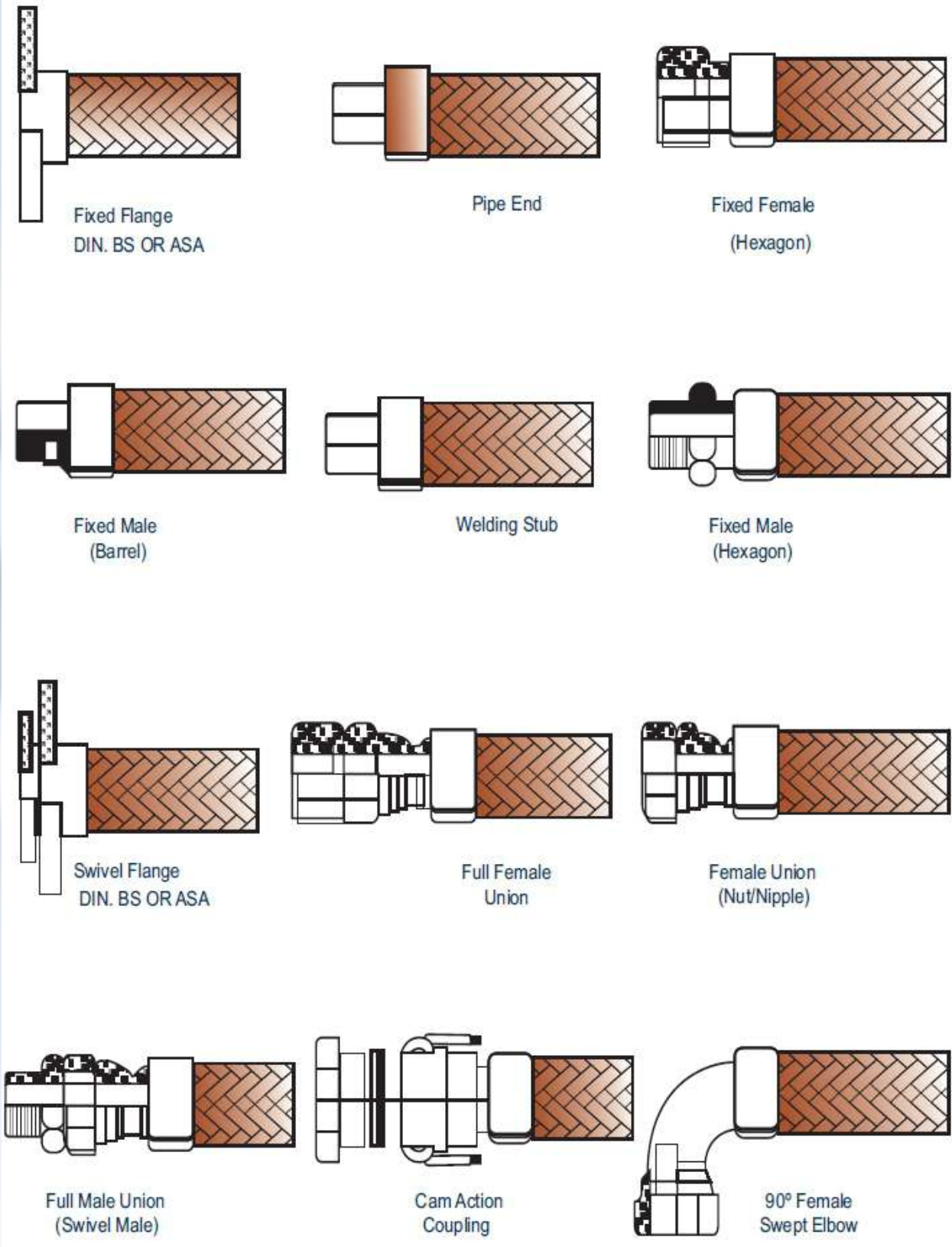

SEISMIC EXPANSION JOINT



Installation shall be installed to maintain proper vapor barrier without inhibiting, restricting or preventing movement of the flexible loop. Schön Flexible Loop are redesigned and usable for expansion and contraction applications, provided each individual application has been properly engineered.

Seismic bracing shall not passthrough building seismic and/or expansion and contraction joints. Seismic bracing shall not connect or tie together different sides or parts of the building structure.

These loops can be designed for almost any amount of movement in any direction. Consideration should be given to the location of the loop within the building or facility. In designing a loop for seismic protection, the function you wish the loop to perform should be considered, ie: minimizing nozzle loads, breaching seismic joints in the building, angular displacement of pipelines traversing know or suspected faults, etc... After an earthquake, Schön Flexible Loops should be visually inspected and pressurized at 1.5 times rated working pressure.

